













APD avalanche photodetection module

-----HC -APRM Series





Product introduction

-  HC-APRM series APD avalanche photodetection module adopts imported APD avalanche photodiodes with high gain, fast response and low dark current. It integrates low-noise broadband transimpedance amplifier, boost and temperature compensation circuits, and has the characteristics of high gain and high sensitivity. The power supply of the module is positive 12 V, and the input optical interface can be optical fiber interface or space incidence. The optical fiber interface is a universal interface for single-mode and multimode optical fibers; multiple photosensitive surfaces can be selected during space incidence, and the external thread adapter for external optical antenna is provided as standard; the electric signal is output from the SMA port, which is very suitable for the detection of weak light signals and the measurement of short pulse signals, and is mainly used in the fields of optical detection, space laser communication, laser radar, distributed optical fiber sensing system, etc.





Product features

-  Si & InGaAs APD
-  3dB bandwidth up to 1.5 G
-  Response Time Min. <0.2ns
-  Integrated Amplifier Circuit
-  Integrated boost and temperature compensation circuit
-  Low noise, high gain
-  $\varnothing 20\text{mm}$ optical antenna with external thread
-  Equipped with M4 female fixing holes
-  Single 12V power supply
-  Compact 47x42x26 mm
-  SMA output
-  Can be customized

Scope of application

-  Ns optical pulse detection
-  Laser radar
-  Space laser communication
-  Distributed optical fiber sensing system
-  Optical detection

Optional

-  Photosensitive surface
-  Bandwidth
-  Gain
-  Coupling mode
-  Digital TTL level output



Technical parameters

Si APD optical detection module					
Parameter	HC-APRM-1G-S	HC-APRM-350M-S	HC-APRM-200M-S	HC-APRM-100M-S	HC-APRM-10M-S
Detector type	Si / APD				
Optical input	Free Space, FC/APC, SMA905				
Wavelength range	400~1100nm				
Peak responsivity	50A/W@800nm, M=100				
Photosensitive surface	500um				
Bandwidth (3dB)	30K~1GHz	350MHz	200M	100M	10M
Conversion gain	1x10 ⁵ V/W	1x10 ⁵ V/W	2x10 ⁶ V/W	2.5x10 ⁶ V/W	20x10 ⁶ V/W @1064nm
Rise time	0.4ns	0.9ns	1.8ns	3.5ns	35ns
Saturated optical power	14uW	36uW	1.8uW	1.5uW	150nW
Coupling mode	AC coupling	DC coupling			
Transimpedance	50Ω				
Equivalent noise	0.52pw/√Hz	0.8pw/√Hz	0.21 pw/√Hz	0.13 pw/√Hz	0.05 pw/√Hz
Total output noise voltage	12mV	9mV	36mV	20 mV	18mV

Si APD optical detection module			Si APD optical detection module (1064nm Enhanced)
Parameter	HC-APRM-400M-S-0.2	HC-APRM-5M-S-1mm	HC-APRM-BW-1064
Detector type	Si / APD		Si/APD 1064nm enhanced
Optical input	Free Space or SMA905		
Wavelength range	400~1100nm		
Responsiveness	55A/W@850nm, M=100		45A/W@1064nm, M=100
Photosensitive	200um	1mm	800um
Bandwidth (3dB)	400MHz	5MHz	10MHz
Conversion gain	2x10 ⁵ V/W	5x10 ⁶ V/W	16x10 ⁶ V/W @1064nm
Rise time	0.9ns	70ns	35ns
Saturated optical power	18uW	1.8uW	180nW

Coupling mode	DC coupling		
Output impedance	50Ω		
Equivalent noise	0.5 pw/√Hz	0.09 pw/√Hz	0.06 pw/√Hz
Total output noise voltage	12mV	6mV	18mV

InGaAs APD optical detection module (fiber input)					
Parameter	HC-APRM-BW-I-FA				
Detector type	InGaAs / APD				
Optical input	Fiber FC/APC				
Wavelength range	800~1700nm				
Peak responsivity	9.5A/W@1550nm M=10				
Photosensitive	75um				
Bandwidth (3dB)	10MHz	100MHz	200 MHz	500 MHz	30K~1.5GHz
Conversion gain	2×10 ⁶ V/W	4×10 ⁵ V/W	3×10 ⁵ V/W	1.4x10 ⁴ V/W	1.4x10 ⁴ V/W
Rise time	35ns	3.5ns	1.8ns	0.7ns	0.2ns
Saturated optical	225 nW	9uW	12μW	270μW	140μW
Coupling mode	DC coupling				AC coupling
Output impedance	50Ω				
Equivalent noise	0.25 pw/√Hz	0.83 pW/√Hz	1.4 pW/√Hz	2.2 pw/√Hz	1.8 pw/√Hz
Total output noise	9mV	20mV	36mV	4mV	6mV

InGaAs APD optical detection module (spatial input)				
Parameter	HC-APRM-BW-I-FS			
Detector type	InGaAs / APD			
Optical input	Spatial light input			
Wavelength range	800~1700nm			
Peak responsivity	9.5A/W@1550nm M=10			
Photosensitive	200um	200um	500um	500um
Bandwidth (3dB)	30K~1.5GHz	200MHz	150 MHz	75MHz
Conversion gain	1.4x10 ⁴ V/W	3x10 ⁵ V/W	2x10 ⁵ V/W	2x10 ⁵ V/W
Rise time	0.2ns	1.8ns	2.3ns	4.6ns
Saturated optical	140μW	12μW	18μW	15uW
Coupling mode	AC coupling	DC coupling		

Output impedance	50Ω			
Equivalent noise	2.46 pW/√Hz	1.5 pW/√Hz	1.4 pW/√Hz	1.44 pW/√Hz
Total output noise	8mV	38 mV	20mV	15mV

General parameters

Parameter	Typical value	Remark
Output electrical signal interface	SMA(Female)	
Output DC Bias	+/-3mV	No input
Maximum output voltage	3.6V	High resistance
	1.8V	50Ω
Power connector	2 p Aviation Plug	
Power supply	DC 12V	Operating voltage
	<150mA	Operating current
Photodamage threshold	10mW	CW or peak power
Operating temperature	-20~65°C	

Characteristic curve

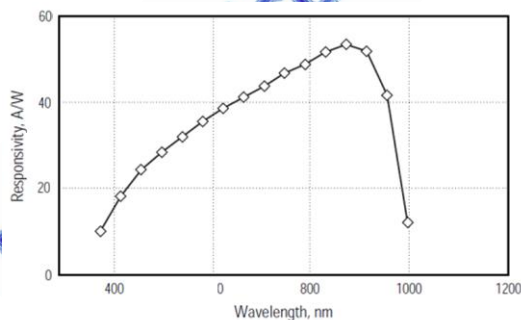

Si(M=100)

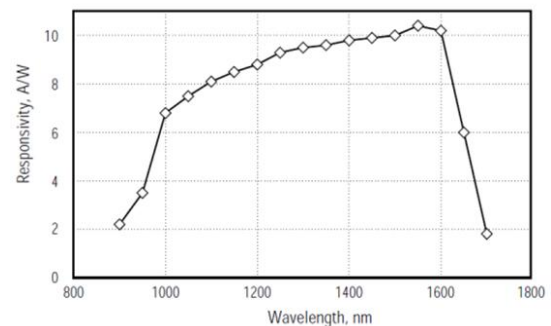

InGaAs(M=10)

Typical spectral response

Mechanical dimensions in mm

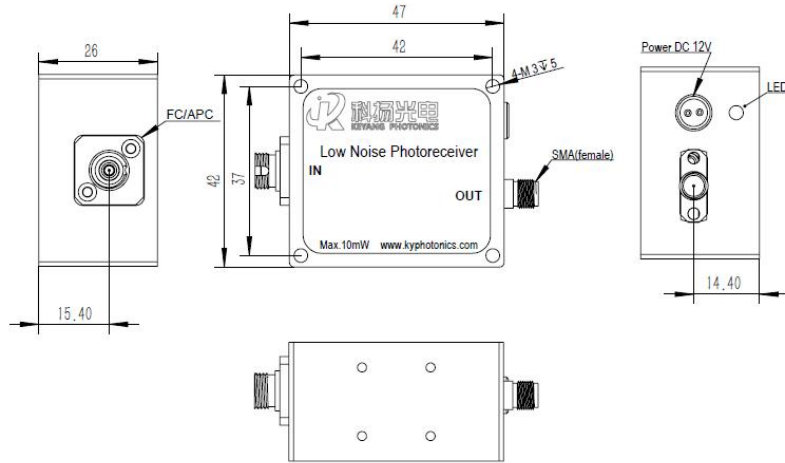

Type of fiber input

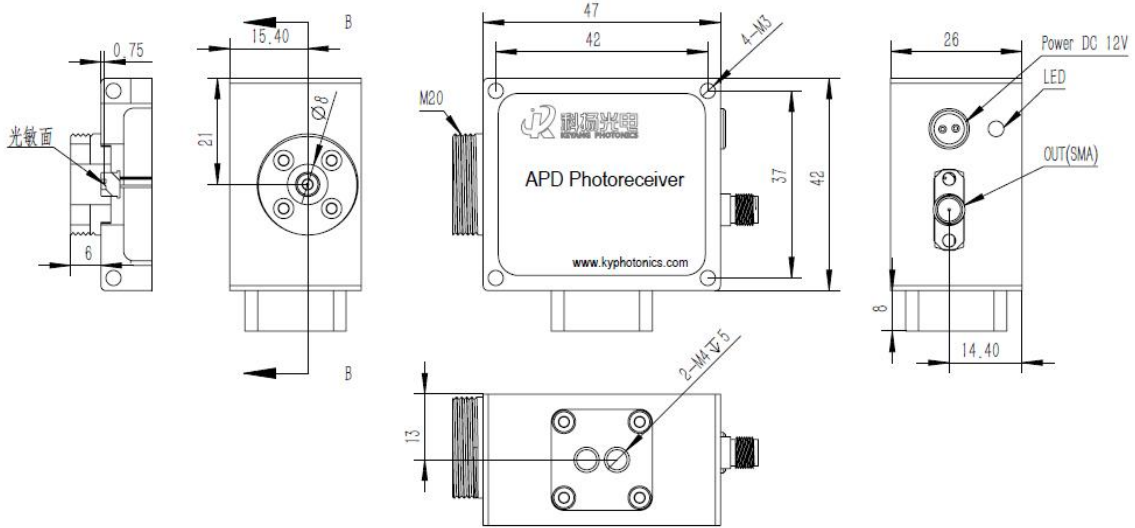

Spatial light input type I

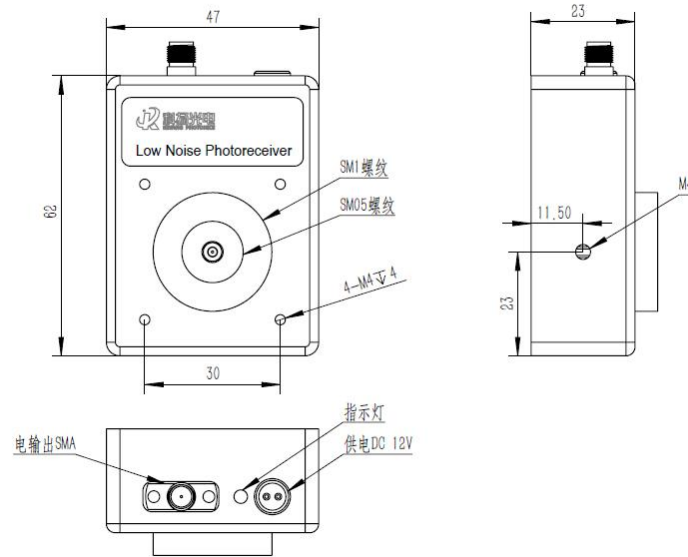

Spatial Light Input Type II

 **Ordering Information HC-APRM-BW-WL-FA/FS-XX**

BW--Operating Bandwidth

WL--Detector Type

S---400-1100NM; I---800-1700NM;

FA/FS --- FA: FC/APC; FS: Free Space

XX--Other special requirements for photosensitive surface, signal format, etc.